

Job Name/Location:

Tag #:

Date:

For: File Resubmit

PO No.:

Approval Other

Architect:

GC:

Engr:

Mech:

Rep:

(Company)

(Project Manager)



LMDN096HV
Multi F Ceiling Concealed Duct
9,000 Btu/h Indoor Unit



Performance:

Nominal Cooling Capacity (Btu/h)	9,000
Nominal Heating Capacity (Btu/h)	10,400

Cooling Nominal Test Conditions:

Indoor: 80°F DB/67°F WB

Outdoor: 95°F DB/75°F WB

Heating Nominal Test Conditions:

Indoor: 70°F DB/60°F WB

Outdoor: 47°F DB/43°F WB

Electrical:

Power Supply (V ¹ /Hz/Ø)	208-230/60/1
Rated Amps (A)	0.40

Piping:

Liquid Line (in, OD)	1/4
Vapor Line (in, OD)	3/8
Drain OD, ID (in)	1-1/4, 1
Temperature Sensor	Thermistor

Features:

- 2 Thermistor control
- Auto operation
- Auto restart
- Control lock function
- Internal Condensate Pump
- Inverter (variable speed fan)
- Group control

Included Accessories:

- Simple Controller with Mode - AKB72955816

Optional Accessories (sold separately)

- LG Programmable Thermostat - PREMTB10U0
- Simple Controller with Mode (Black) - PQRVCLOQ
- Simple Controller with Mode (White) - PQRVCLOQW
- Simple Controller without Mode (Black) PQRCHCAOQ
- Simple Controller without Mode (White) - PQRCHCA0QW
- AC Smart Premium - PQCSW421E0A
- ACP Premium - PQCP22A1
- ACP Standard - PQCP22N1
- LonWorks Gateway - PQNFB16A1
- BACnet Gateway - PQNFB17C1
- AC Ez - PQCSZ250S0
- Dry Contact Unit Dry Contact Unit (1 contact, 24 VAC external power) - PQDSB1
- Dry Contact Unit Dry Contact Unit (2 input, power from indoor unit) - PQDSBC
- Dry Contact for Third Party Thermostat - PQDSBNGCM1

For a complete list of available accessories, contact your LG representative.

Operating Range:

Cooling (°F WB)	57-77
Heating (°F DB)	59-81

Unit Data:

Refrigerant Type	R410A
Refrigerant Control	EEV
Sound Pressure ² H/M/L (±3 dB(A))	30/26/23
Primary Filter	Washable Pre-filter
Net Unit Weight (lbs)	39
Shipping Weight (lbs)	45

Fan:

Type	Sirocco
Quantity	2
Motor/Drive	Brushless Digitally Controlled/Direct
Airflow Rate H/M/L (CFM)	318/247/194
External Static Pressure ^{3 4} (in wg)	0.1
Minimum External Static Pressure ⁵	0.0
Maximum External Static Pressure ⁵	0.2

Notes:

1. Acceptable operating voltage: 187V-253V.
2. Sound Pressure levels are tested in an anechoic chamber under ISO Standard 1996.
3. Adjust fan speed to correct for static pressure increases when using field supplied air filter.
4. At factory fan speed setting.
5. Air flow rate (CFM) at high speed.
6. See Engineering Manual for sensible and latent capacities.
7. All power/communication cable to be minimum 18 American wire gage (AWG), 4-conductor, stranded, shielded and must comply with applicable local and national code.
8. Power wiring cable size must comply with the applicable local and national code.
9. This unit comes with a dry helium charge.
10. Corresponding refrigerant piping length is in accordance with standard length of each outdoor unit and the level difference is 0 ft.
11. Must follow installation instructions in the applicable LG installation manual.



Job Name/Location:

LMDN096HV
 Multi F Ceiling Concealed Duct
 9,000 Btu/h Indoor Unit



Tag #: _____
 Date: _____
 PO No.: _____

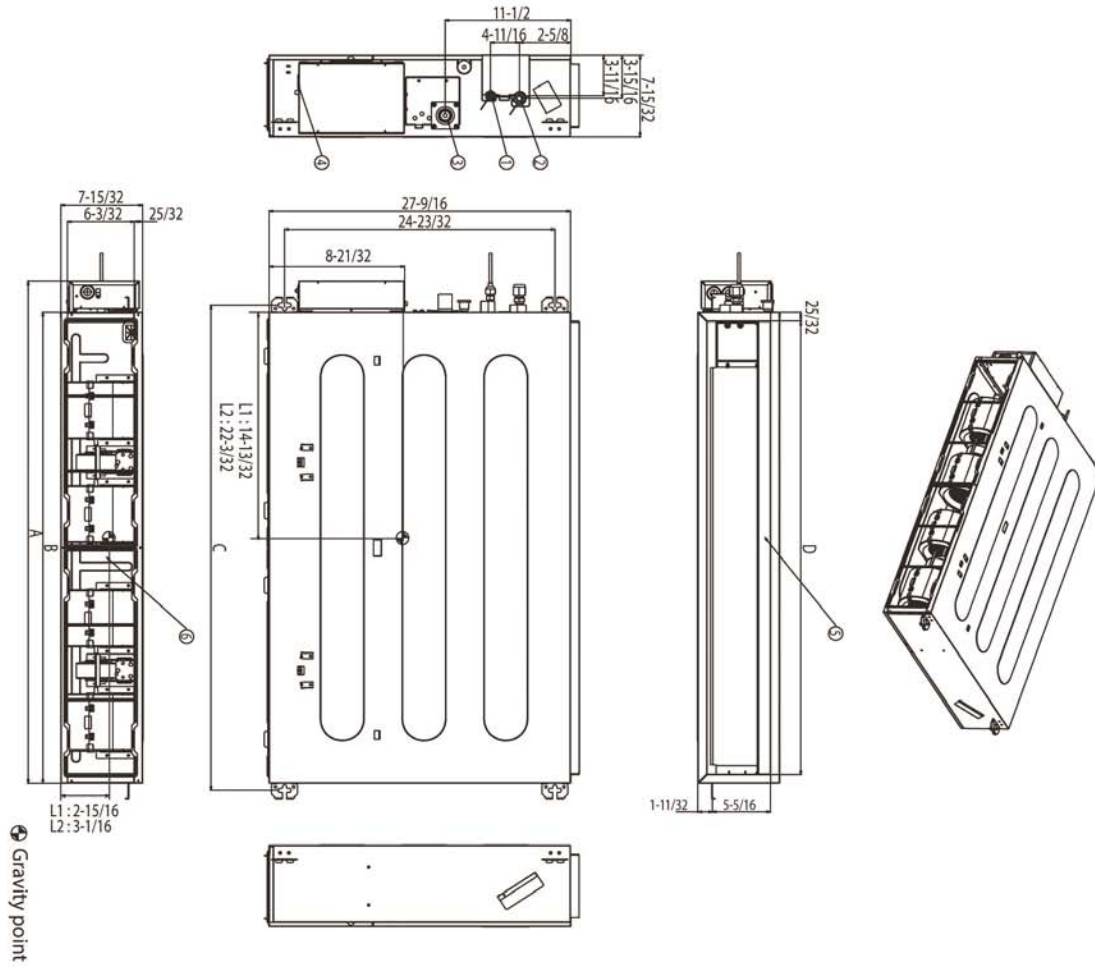

Number	Name	Description
1	Liquid pipe connection	
2	Gas pipe connection	
3	Drain pipe connection	
4	Power supply connection	
5	Air discharge	
6	Air suction	

(unit: inch)

Model Number	A	B	C	D
LMDN096HV	30-15/32	27-9/16	28-27/32	25-31/32
LMDN126HV	38-11/32	35-7/16	36-23/32	33-27/32
LMDN186HV				

(unit: inch)

For continual product development, LG reserves the right to change specifications without notice.